

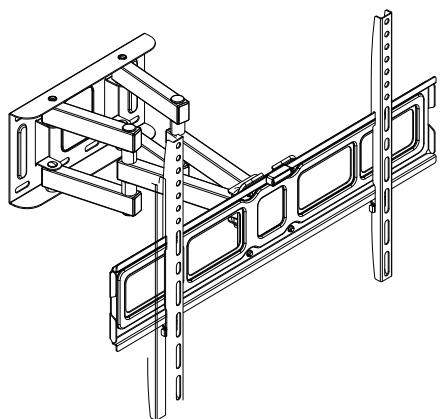

TV nosač za LCD i LED televizore

LCDH-FC46

Uputstvo za upotrebu



A		(M8*25) 4PCS	I		(ø13*ø6.5*15) 4PCS
B		(M6*25) 4PCS	J		(M6*12) 2PCS
C		(M5*25) 4PCS	K		(M6) 2PCS
D		(ø6) 10PCS	L		40*17 1PC
E		(ø5) 4PCS	M		1PC
F		(ø8) 4PCS	N		2PCS
G		(ø10*50) 6PCS			
H		(M6*50) 6PCS			

KORAK 2 Postavljanje nosača na TV

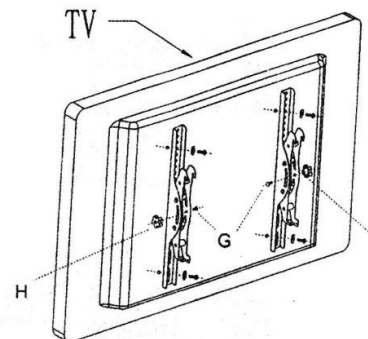

Montirajte šine nosača na TV odgovarajućim šarafima i podloškama



KORAK 1 Fiksiranje na betonsku podlogu

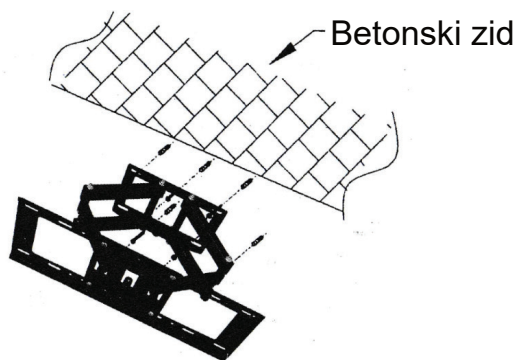

Pomoću tipli (G) i šarafa (H) montirajte nosač na zid

KORAK 3 Postavljanje TV-a na montiran nosač

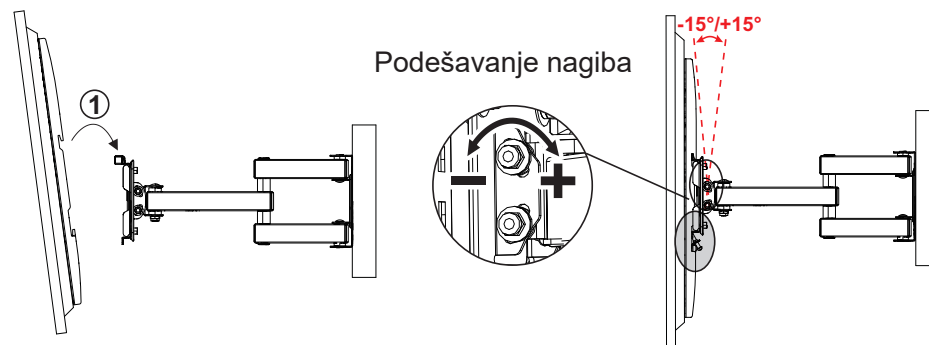

Oznaka: LCDH-FC46; Proizvođač: Andi Metal;

Zemlja porekla: Kina

Uvoznik za Srbiju: Elementa d.o.o., Srbija, Subotica, Jovana Mikića 56;

Telefon: 024/686-270

www.elementa.rs